



USER'S GUIDE
V: 815-01



TAB803B

Streaming Media Box

For the most up-to-date version of this User's Guide, go to
www.zekitablet.com

Warnings and Precautions

- **CAUTION:** TO PREVENT ELECTRIC SHOCK, MATCH WIDE BLADE OF PLUG TO WIDE SLOT, FULLY INSERT.
- **WARNING:** To reduce the risk of fire or electric shock, do not expose this apparatus to rain or moisture.
- **AVERTISSEMENT:** Pour réduire le risque d'incendie ou de choc électrique, ne pas exposer cet appareil sous la pluie et l'humidité.
- **WARNING:** Changes or modifications to this unit not expressly approved by the party responsible for compliance could void the user's authority to operate the equipment.
- **WARNING:** Do not place this unit directly onto furniture surfaces with any type of soft, porous, or sensitive finish. As with any rubber compound made with oils, the feet could cause marks or staining where the feet reside. We recommend using a protective barrier such as a cloth or a piece of glass between the unit and the surface to reduce the risk of damage and/or staining.
- **PRÉCAUTION:** *Danger d'explosion si les piles sont remplacées de façon incorrect. Remplacer les piles seulement par le même type de pile ou l'équivalent.*
- **WARNING:** The battery, batteries, and battery pack shall not be exposed to excessive heat such as sunshine, fire, or the like.
- **WARNING:** Lithium batteries, like all rechargeable batteries are recyclable and should be recycled or disposed of in normal household waste. Contact your local government for disposal or recycling practices in your area. They should never be incinerated since they might explode.
- **WARNING:** Shock hazard - Do Not Open.
- **AVIS: RISQUE DE CHOC ÉLECTRIQUE - NE PAS OUVRIR**
Mains Plug or Direct plug-in adapter is used as disconnect device and it should remain readily operable during intended use. In order to disconnect the apparatus from the mains completely, the Mains Plug or Direct plug-in adapter should be disconnected from the mains socket outlet completely.

La fiche d'alimentation ou adaptateur de courant est utilisé comme dispositif de déconnexion et doit rester accessible pendant l'utilisation. Pour mettre l'appareil hors tension, la fiche ou adaptateur de courant doit être débranché de la prise de courant.

- Your device is designed to be in compliance with Radio Waves exposure regulations and does not exceed the limits for exposure to radio waves (radio frequency electromagnetic fields) in accordance with the Federal Communications Commission (FCC). A substantial safety margin is set to assure the safety of all persons, regardless of health. A unit of measurement known as the Specific Absorption rate, or SAR is utilized for the radio wave exposure guidelines. The SAR measurement for devices does not exceed 1.6W/kg. The actual SAR values for your device, while in use, are normally well below the stated values. The operating power of your device is automatically decreased when full power is not needed for the wireless connection to increase system efficiency and to minimize interference on the network. The lower the power output of the device the lower its SAR value.



WARNING: TO REDUCE THE RISK OF ELECTRIC SHOCK, DO NOT REMOVE COVER (OR BACK). NO USER-SERVICEABLE PARTS INSIDE. REFER SERVICING TO QUALIFIED SERVICE PERSONNEL.



The lightning flash with arrowhead symbol, within an equilateral triangle, is intended to alert the user to the presence of uninsulated "dangerous voltage" within the product's enclosure that may be of sufficient magnitude to constitute a risk of electric shock to persons.



The exclamation point within an equilateral triangle is intended to alert the user to the presence of important operating and maintenance (servicing) instructions in the literature accompanying the appliance.



This symbol indicates that this product incorporates double insulation between hazardous mains voltage and user accessible parts.

Important Safety Instructions

1. Read these Instructions.
2. Keep these Instructions.
3. Heed all Warnings.
4. Follow all instructions.
5. Do not use this apparatus near water.
6. Clean only with a dry cloth.
7. Do not block any ventilation openings. Install in accordance with the manufacturer's instructions.
8. Do not install near any heat sources such as radiators, heat registers, stoves, or other apparatus (including amplifiers) that produce heat.
9. Do not defeat the safety purpose of the polarized or grounding - type plug. A polarized plug has two blades with one wider than the other. A grounding type plug has two blades and a third grounding prong. The wide blade or the third prong are provided for your safety. When the provided plug does not fit into your outlet, consult an electrician for replacement of the obsolete outlet.
10. Protect the power cord from being walked on or pinched particularly at plugs, convenience receptacles, and the point where they exit from the apparatus.
11. Only use attachments/accessories specified by the manufacturer.



Use only with a cart, stand, tripod, bracket, or table specified by the manufacturer, or sold with the apparatus. When a cart is used, use caution when moving the cart/apparatus combination to avoid injury from tip-over.

13. Unplug this apparatus during lightning storms or when unused for long periods of time.
14. Refer all servicing to qualified service personnel. Servicing is required when the apparatus has been damaged in any way, such as power-supply cord or plug is damaged, liquid has been spilled or objects have fallen into the apparatus, the apparatus has been exposed to rain or moisture, does not operate normally, or has been dropped.
15. DO NOT place objects on top of the device, as objects may scratch the screen.
16. DO NOT expose the device to dirty or dusty environments.
17. DO NOT place the device on an uneven or unstable surface.
18. DO NOT insert any foreign objects into the device
19. DO NOT expose the device to strong magnetic or electrical field.
20. DO NOT expose the device to direct sunlight as it can damage the LCD Screen.
21. Keep it away from heat sources.
22. The device and the adapter may produce some heat during normal operation
23. Clean the touch screen with a soft cloth. If needed, dampen the cloth slightly before cleaning.

Never use abrasives or cleaning solutions.

24. Disconnect the device from an electrical outlet and power off before cleaning the device
25. DO NOT disassemble the device, only a certified service technician should perform repair.
26. Please select a suitable volume and avoid loud sounds while using the headphones
27. Only use the original charger supplied with this device.
28. Please do not disconnect the device while downloading and uploading, or it may cause application errors.

FCC Warnings

WARNING: Changes or modifications to this unit not expressly approved by the party responsible for compliance could void the user's authority to operate the equipment.

NOTE: This equipment has been tested and found to comply with the limits for a Class B digital device, pursuant to Part 15 of the FCC Rules. These limits are designed to provide reasonable protection against harmful interference in a residential installation. This equipment generates, uses, and can radiate radio frequency energy and, if not installed and used in accordance with the instructions, may cause harmful interference to radio communications. However, there is no guarantee that interference will not occur in a particular installation. If this equipment does cause harmful interference to radio or television reception, which can be determined by turning the equipment off and on, the user is encouraged to try to correct the interference by one or more of the following measures:

- Reorient or relocate the receiving antenna.
- Increase the separation between the equipment and receiver.
- Connect the equipment into an outlet on a circuit different from that to which the receiver is connected.
- Consult the dealer or an experienced radio/TV technician for help.

Additional Warnings

- The apparatus shall not be exposed to dripping or splashing and that no objects filled with liquids, such as vases, shall be placed on apparatus.
L'appareil ne doit pas être exposé aux écoulements ou aux éclaboussures et aucun objet ne contenant de liquide, tel qu'un vase, ne doit être placé sur l'objet.
- Battery shall not be exposed to excessive heat such as sunshine, fire or the like.
Les piles ne doivent pas être exposées à de forte chaleur, tel qu'à la lumière du soleil, au feu ou autres choses de semblable.
- Caution marking is located at the rear or bottom of the apparatus.

Attention marquage est situé sur le panneau arrière ou inférieur de l'unité.

- The marking information is located at the rear or bottom of apparatus.

Le marquage est situé sur le panneau arrière ou inférieur de l'unité.

Table of Contents

- Table of Contents** 4-5
- Streaming Media Box** 6
 - Features Included
- Setup** 7
 - Power
 - Remote
- Introduction** 8-11
- Connecting to a TV** 12
 - Connecting with HDMI (Best)
 - Connecting with AV (Good)
- 2-in-1 Remote** 13
 - Connecting the Remote
 - Using the Remote
- Connecting to the Internet** 14
 - Connecting to Wireless Internet
 - Connecting to Wired Internet
- Browser** 15
 - Navigating the Browser
- Basic Use** 16
 - Using the remote
 - Notifications
- On-Screen Introduction** 17
 - Icons You Should Know
- Home Menu** 18

Table of Contents

- Apps..... 19-20**
 - Accessing the App Menu
 - Adding Apps to the Home Screen
 - Removing Apps from the Home Screen
 - Managing Apps
 - Removing Apps

- Connecting Storage Devices 21**
 - Connecting a USB Drive
 - Removing a USB Drive
 - Connecting a SD card
 - Removing a Micro SD card

- File Explorer 22**
 - Using the File Explorer
 - File Explorer Menu

- Transferring Files to the Local Memory 23**
 - Transferring Files to the Media Box

- Company Information 24**
 - International Support
 - Contact Information
 - Warranty
 - Green Initiative

Streaming Media Box

Features

- Android OS
- Built-in 1GB RAM
- HDMI output
- Ethernet port
- 2 USB ports
- SD memory card reader
- 3.5mm audio/video output
- Built-in WiFi 802.11 b/g/n
- 4GB installed flash memory
- Expandable memory
- Digital audio
- Digital photos
- eBooks: PDF, PDF DRM, EPUB, EPUB DRM
- Digital video
- DC power input: requires an AC/DC power adapter (included)

Included

- Wireless USB Receiver
- Remote with keyboard
- HDMI cable
- AC/DC power adapter
- 2 x AAA batteries

Note: Specifications are subject to change without prior notice.

Setup

Power

Requires an AC/DC power adapter (included)

1. Plug the included AC/DC Power adapter into a standard AC outlet.
2. Press the **Power** button.

The power indicator will display a red light for standby mode, and blue for power on.

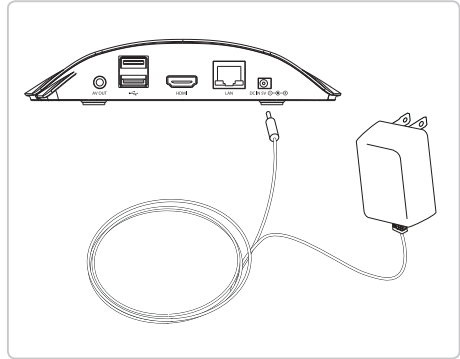

Remote

Requires 2 x AAA batteries

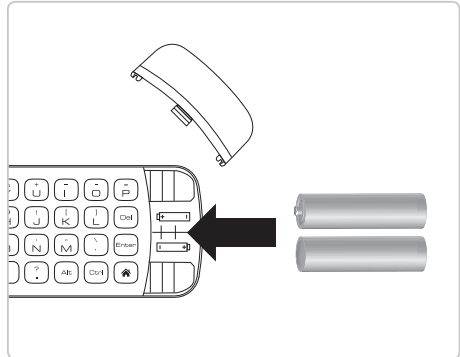

Introduction

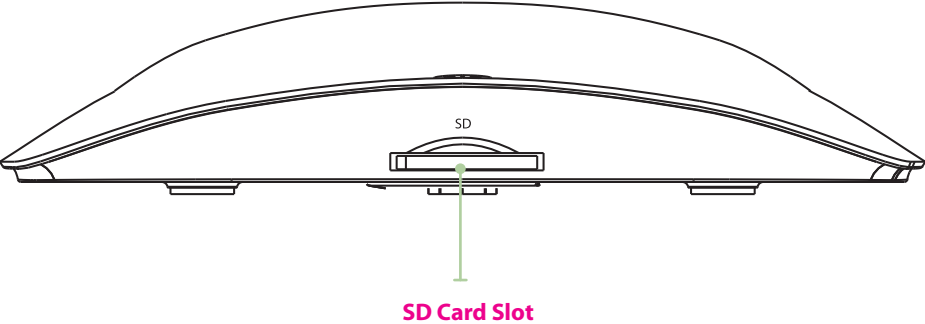
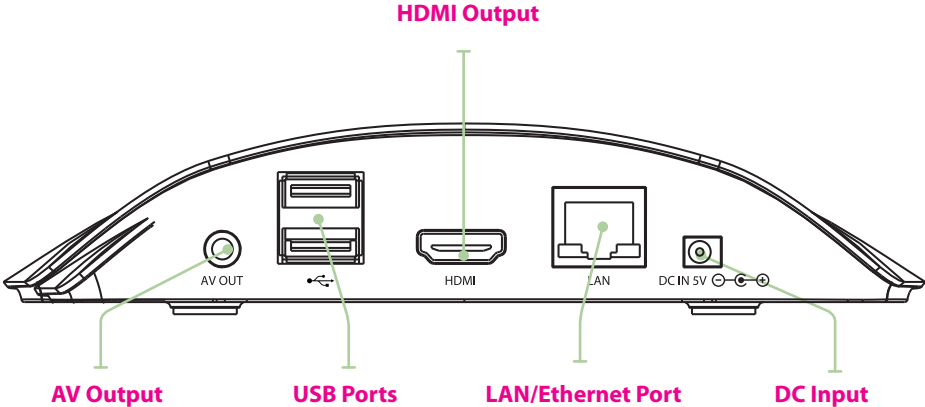

Introduction

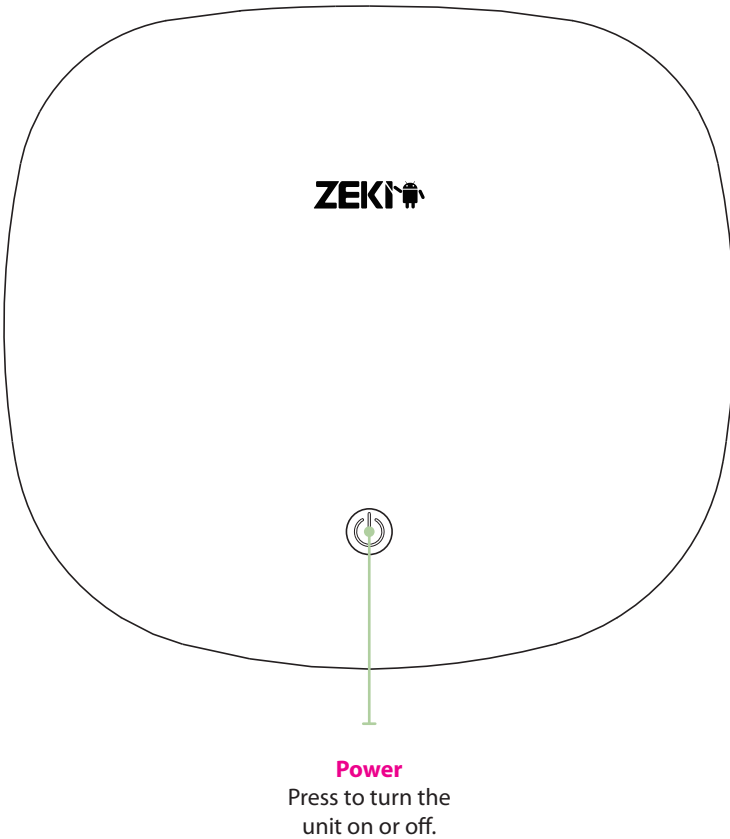

Introduction

Front

On-screen and media controls.

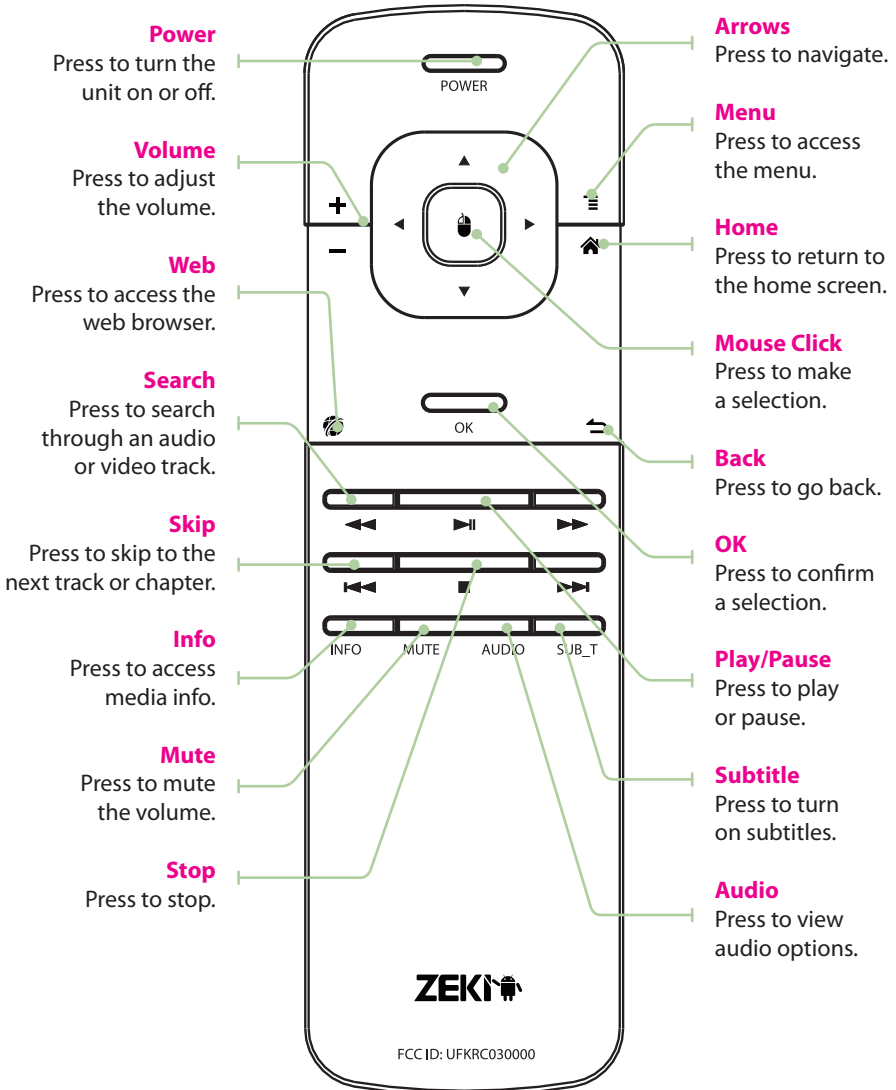

Introduction

Back

Keyboard for text input.

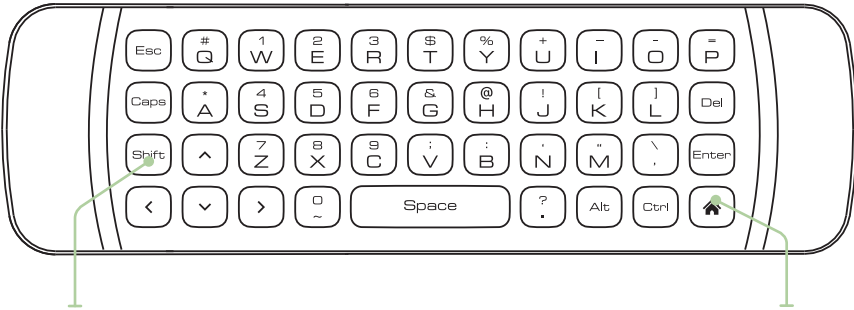

Shift

Press and hold to use the alternate keys.

Home

Press to return to the home screen.

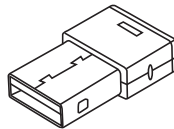

Wireless USB Receiver

Plug into the **USB Port** on the unit to use the wireless remote.

Connecting to a TV

Connecting with HDMI (Best)

Requires an HDMI cable (included).

1. Use the included HDMI cable to connect the **HDMI Out** on the unit to an HDMI In on a television.

If the screen is not displayed automatically, adjust the connected televisions input setting to match the input used in the previous step.

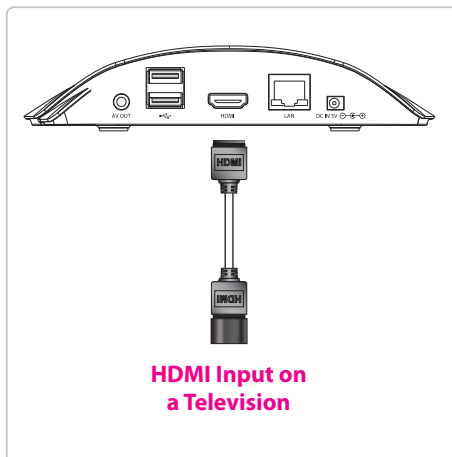

Connecting with AV (Good)

Requires a Note : 14.5mm AV cable (not included).

1. Use an AV cable to connect the **AV Out** on the unit to an AV In on a television.
2. Adjust the connected televisions input setting to match the input used in the previous step.

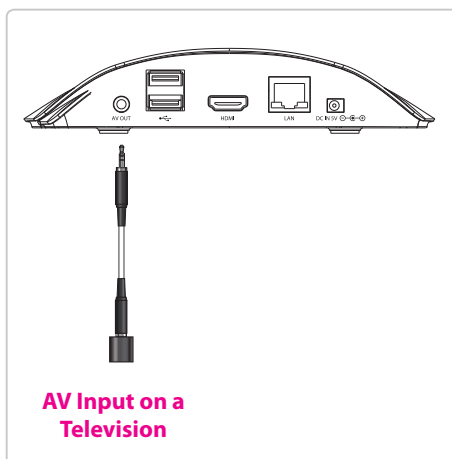

2-in-1 Remote

Connecting the Remote

1. Connect the **Wireless USB Receiver** to the **USB Port** on the back of the unit.
2. The wireless remote should now appear on the screen as a pointer.

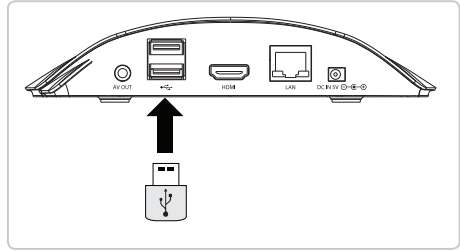

Using the Remote

- The wireless remote acts as a pointer just like a mouse on a computer. It also features a full function keyboard on the reverse side.
- Aim the remote at the media box and simply move it to move the pointer on the screen.
- Make selections using the **Mouse Click** button.
- The bottom half of the front side of the remote contains media controls for any video or media being played on the screen.
- On the back of the remote, the keyboard can be used when any input form requires typing. Simply turn the remote over and begin typing.

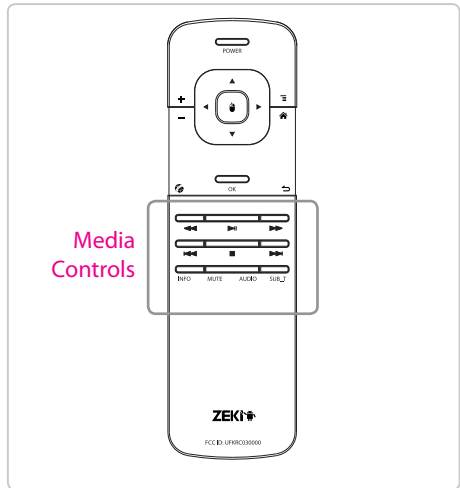

*Note: When finished typing, use the **Mouse Click** or **Enter** button on the on screen keyboard, not the **Enter** button on the physical keyboard.*

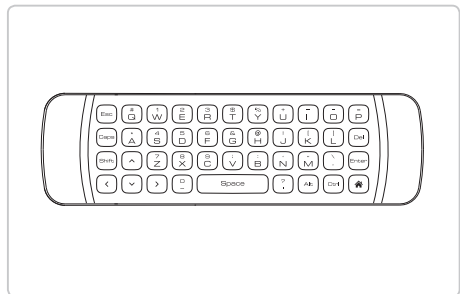

- After a few minutes of inactivity, the wireless remote will go into sleep mode. To wake it up simply press any button.

Note: This remote uses a USB connection and does not have an IR code.



Connecting to the Internet

Connecting to Wireless Internet

1. Press the **Settings**  icon.
2. Locate the **Wi-Fi**  setting and slide it to the **On** position.
3. Select a network from the list of available networks.

*To refresh the list of available networks, press the **Scan** button.*

*To manually add a network, select the **Add Network** button.*

4. Select **Connect** from the pop up menu.
5. If the network is secured with a password, enter the password to continue.
6. Once finished connecting, the display will show **Connected** under the name of the network.

Connecting to Wired Internet

1. Connect a LAN cable (not included) to the **LAN/Ethernet Port** on the back of the unit.
2. Press the **Settings**  icon.
3. Under the Wireless & networks settings, select **More** and then select **Ethernet**.
4. If the network is secured with a password, enter the password to continue.

Note: A wired internet connection will provide the best quality connection for streaming media.

Browser

Navigating the Browser

Make sure you are connected to the internet before attempting to use the browser.

1. Press **Web**  button on screen or on the remote.
2. Type in a web address or a search term to begin browsing.

*Type using the on-screen keyboard by pressing the **Mouse Click** button on a letter, or use the keyboard on the remote.*

*Note: When finished typing, use the **Mouse Click** or **Enter** button on the on screen keyboard, not the **Enter** button on the keyboard physical keyboard.*

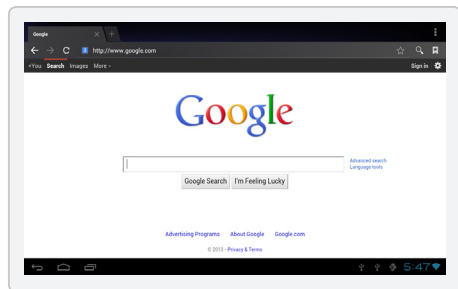
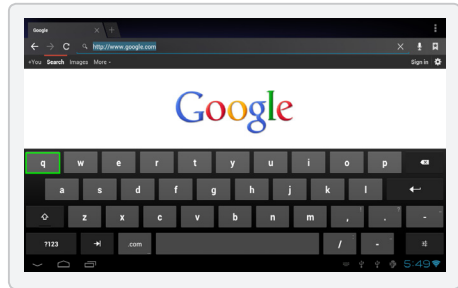

Basic Use

Using the remote

With your wireless remote, you can gesture in a variety of motions.

Click

Use the **Mouse Click** button to click, similar to the left click button on a regular mouse, and make a selection.

Flick (Fig. 1)

Press and hold the **Mouse Click** button on an area of the screen, then move the remote quickly toward an edge of the screen and let go. This will result in a fast scroll or in menus such as the app menu, advance to the next screen.

Drag (Fig. 2)

Press and hold the **Mouse Click** button on an object until it becomes active, then move the remote to drag it to a new position and let go of the button.



Notifications

Items will display in the lower right hand corner of your screen alerting you to activity such as the progress of a download, or a new email message.

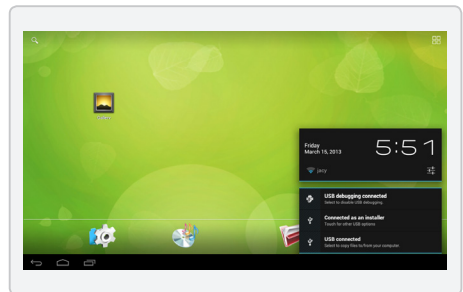

On-Screen Introduction

Icons You Should Know

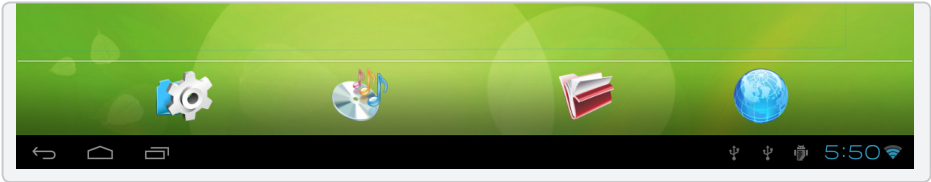

Wifi Indicator

Indicates if a WiFi signal is available and the strength of a connected signal.



Menu

Press to view the menu.



Back

Press to return to a previous screen.



App Menu

Press to view all running applications and windows.



Home

Press to return to the home screen.



Search

Press to begin a Google search of the internet.



Screens

Press to view all running applications and windows.

Home Menu

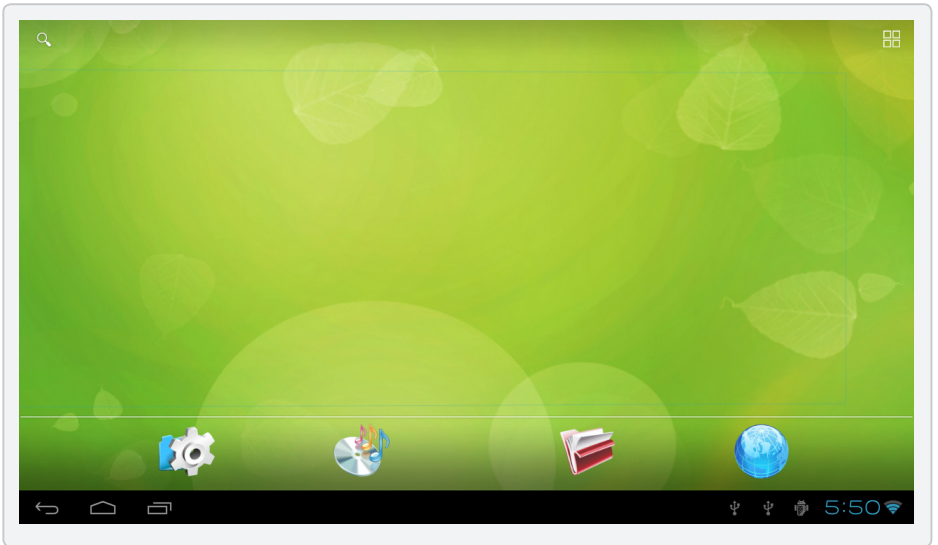

The home menu, located at the bottom of your screen, provides quick and easy access to the most important functions of the media box.

Note: These icons cannot be changed.



Settings

Press to access the settings menu.



File Browser

Press to enter the file browser.

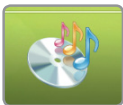

Music

Press to browse through loaded music files.



Web

Press to access the web browser.

Apps

Accessing the App Menu

1. Press the **App Menu**  button in the upper right hand corner.
2. This will load the App menu, which shows all installed apps and widgets.

Note: App menu is reflective of apps installed on the tablet and will likely change from the figure shown. Additional apps may be downloaded in the Amazon App market.

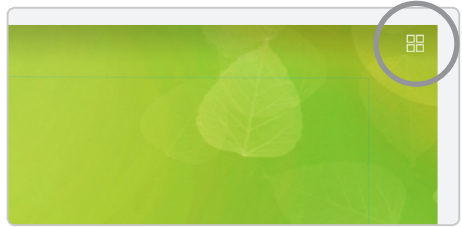

Adding Apps to the Home Screen

1. Press the **App Menu**  button in the upper right hand corner for the App menu to appear.
2. Press and hold the **Mouse Click Button** on an app icon and wait for the screen to appear. Drop the icon wherever it is desired.
3. Once placed, press and hold the **Mouse Click Button** on the icon to move it again.



Removing Apps from the Home Screen

1. Press and hold the **Mouse Click Button** on the desired app icon.
2. Drag it to the **Remove** option at the top of the screen and let go.

Apps

Managing Apps

1. Press the **Settings**  icon.
2. Select **Apps**.
3. From this menu you can view and modify all installed apps.



Removing Apps

1. Select the app you want to uninstall.
2. Press the **Uninstall** button.
3. The tablet will prompt ask you if you're certain you want to uninstall this app, select **Ok**.
4. The app will be uninstalled.

Warning: The selected app and all related content will be completely removed from the tablet.

Note : The apps pre-loaded onto the unit can not be uninstalled.

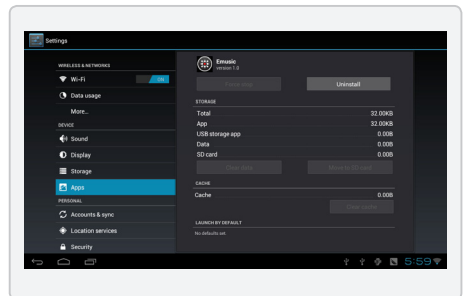

Connecting Storage Devices

Connecting a USB Drive

1. Insert a USB Drive into one of the **USB Slots** on the back of the unit.

A notification will pop up saying the USB device has been mounted.

2. Press the **File Explorer**  icon and select **USB Drive** to explore the contents of the connected drive.

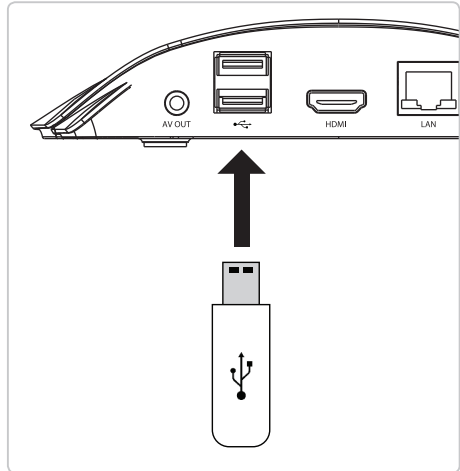

Removing a USB Drive

1. Press the **Settings**  button to access the settings menu.
2. Select **Storage**.
3. Find the connected device in the list and select **Unmount Shared Storage**.
4. Remove the drive.

Connecting a SD card

1. Insert the SD Card into the **SD Card Slot**.

A notification will pop up saying the SD Card has been mounted.

2. Press the **File Explorer**  icon and select **SD Card** to explore the contents of the connected drive.

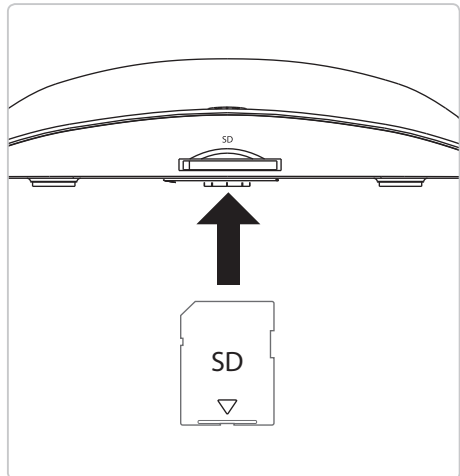

Removing a Micro SD card

1. Press the **Settings**  button to access the settings menu.
2. Select **Storage**.
3. Select **Unmount Shared Storage**.
4. Remove the card gently.

File Explorer

Using the File Explorer

- The **File Explorer** allows you to access all the stored media on your media box.
1. To access it, simply click the **File Explorer** icon on the home menu.
 2. In the equipment section, select where you are trying to access files from. You can access files from:
 - The media box
 - Your local connected network
 - A connected USB flashdrive
 - An inserted SD card

Note: You must select an option before accessing any files.

Note: To access files on your local network you must have file sharing enabled.

3. Select one of these options and a list of available files will appear.

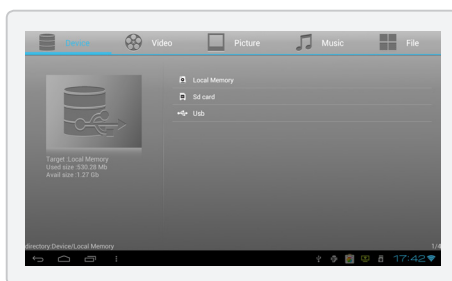
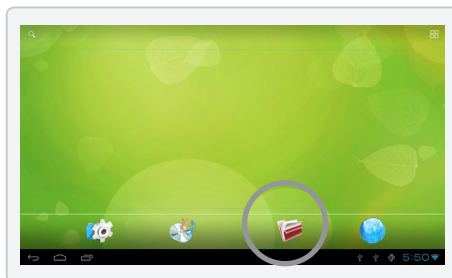

File Explorer Menu

1. In the File Explorer, press the menu button at the bottom of the screen. A menu will pop up on the bottom of the screen.
2. To modify an object using the menu, select it from the list and press and hold the **Mouse Click** button. From this menu you can modify the object you have selected, such as renaming it or copying it.

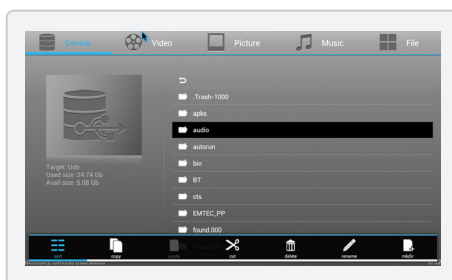

Transferring Files to the Local Memory

Transferring Files to the Media Box

1. To allow easier access to your media, files can be transferred to the media box's local memory so they can be accessed without loading an SD card or USB Flashdrive.
2. Using the **Mouse Click** button, press and hold an item in the file explorer.
3. From the pop up menu, select **Copy**.
4. Return to the equipment screen, and choose **Local Memory**.
5. Press the menu button on the bottom, and select **Paste**.
6. The media can now be removed while still having access to the file.

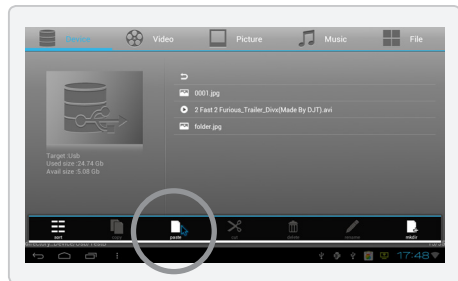
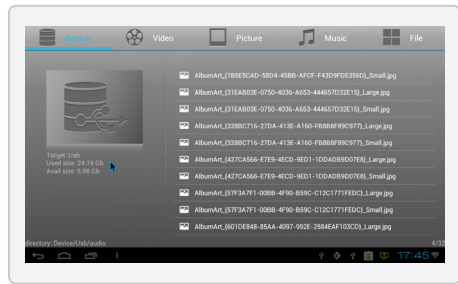
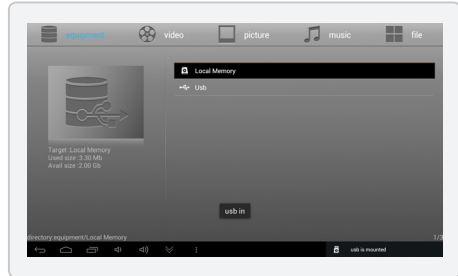

Company Information

International Support

To download this User's Guide in English, Spanish, or French, or to get answers to frequently asked questions, visit the support section at www.zeki-tablet.com.

Para descargar este Manual del Usuario en inglés, español y francés, o para obtener respuestas a preguntas frecuentes, visite la sección de apoyo en www.zeki-tablet.com.

Pour télécharger ce guide de l'utilisateur en anglais, espagnol ou français, ou pour obtenir des réponses à des questions fréquemment posées, consultez la rubrique d'assistance sur www.zekitablet.com.

Contact Information

Email Support: prodinfo@dpiinc.com

Email Parts: partsinfo@dpiinc.com

Phone Support: 1-888-999-4215

Website: www.zekitablet.com

Warranty

For Warranty Information and the most up-to-date version of this User's Guide, go to: www.zekitablet.com

Green Initiative



Environmental Commitment to 'Protect for Today and Sustain for Tomorrow'
On a continual basis DPI, Inc. is making efforts to sustain the environment and improve the recyclability of its products and packaging.

Focusing on "protecting for today and sustaining for tomorrow" DPI, Inc. has committed to reducing packaging size, increasing the usage of recyclable plastics, and ensuring that packaging and manuals are made with up to 85% recycled material. In addition to material consideration, DPI, Inc. has also focused on the finer details that positively impact the environment such as employing the usage of soy-based inks.

DPI, Inc. also ensures that the factories that produce the company's wide variety of consumer electronics adhere to environmentally friendly air and water restrictions. This is yet another example that every step of the way DPI, Inc. is making efforts to lessen any impact on the environment.

DPI, Inc. also engages in conversations with Energy Star in order to ensure that the consumer electronics being produced meet high standards of energy efficiency. The ultimate goal is keeping energy costs for consumers low while providing quality, feature-rich products.